

TURBINE ENGINEERING SERVICES

OUR SERVICES



Contents

A unique global perspective	03	Knowledge transfer	09
Delivering an outstanding turbine engineering service	04	Mechanical engineering	10
Broad expertise	05	Control system	11
Supporting turbine design at every stage	06	Research and development	12
Wind turbine track record	07	Performance and load calculations	14
Bladed	08	Assessing new technologies	15



A unique global perspective

DNV has a unique global perspective based on experience.

With Renewables offices located globally, DNV is a leading provider of independent wind turbine, tidal turbine and wave energy engineering services. These are delivered as Garrad Hassan Turbine Engineering, in recognition of our rich heritage in this field as Garrad Hassan.

Our Garrad Hassan Turbine Engineering services are delivered by a world-leading design consultancy for wind turbines, tidal turbines and wave energy devices. We provide design support services that enable our customers to progress from a blank sheet of paper to a viable design.

DNV has more than 25 years of experience in the design of wind turbines, having contributed to the design and analysis of literally 100's of wind turbine models. As well as providing a range of specialized engineering services, in the last 10 years we have developed more than 12 complete wind turbine models ranging from 1.0 MW to 8 MW. Garrad Hassan Turbine Engineering is delivered by a team of 70 experienced engineers, who combine experience of numerical modelling, control, mechanical, electrical & marine engineering.



Delivering an outstanding turbine engineering service

The design of modern wind turbines is a complex, iterative process requiring multi-disciplinary knowledge and experience. DNV has been at the forefront of turbine design technology for nearly three decades and is unique in terms of its depth and breadth of service offering. Our experts have provided services and products to the majority of leading wind turbine manufacturers for the development of both onshore and offshore wind turbines. Our own turbine design software, Bladed, is built on years of model development and validation, making it the industry standard for turbine design.

Regularly working in multi-disciplinary teams, our specialists provide customers with turbine design and analysis solutions. The design process comprises a series of activities ranging from concept design and cost-of-energy assessment, through control design and computer modelling for performance and load calculations, structural component optimization, development of mechanical, electrical and control sub-system specifications, preparation of certification ready design documentation and controller commissioning.

“The development of the modern wind turbine has seen us move from farm machine to floating power station in less than 3 decades. DNV has been involved at every step, pioneering the development of robust numerical models and the collection of detailed loading and performance measurements. This makes us uniquely qualified to provide our customers with outstanding turbine engineering services.”

Aristeidis Chatzopoulos, Head of Turbine Engineering

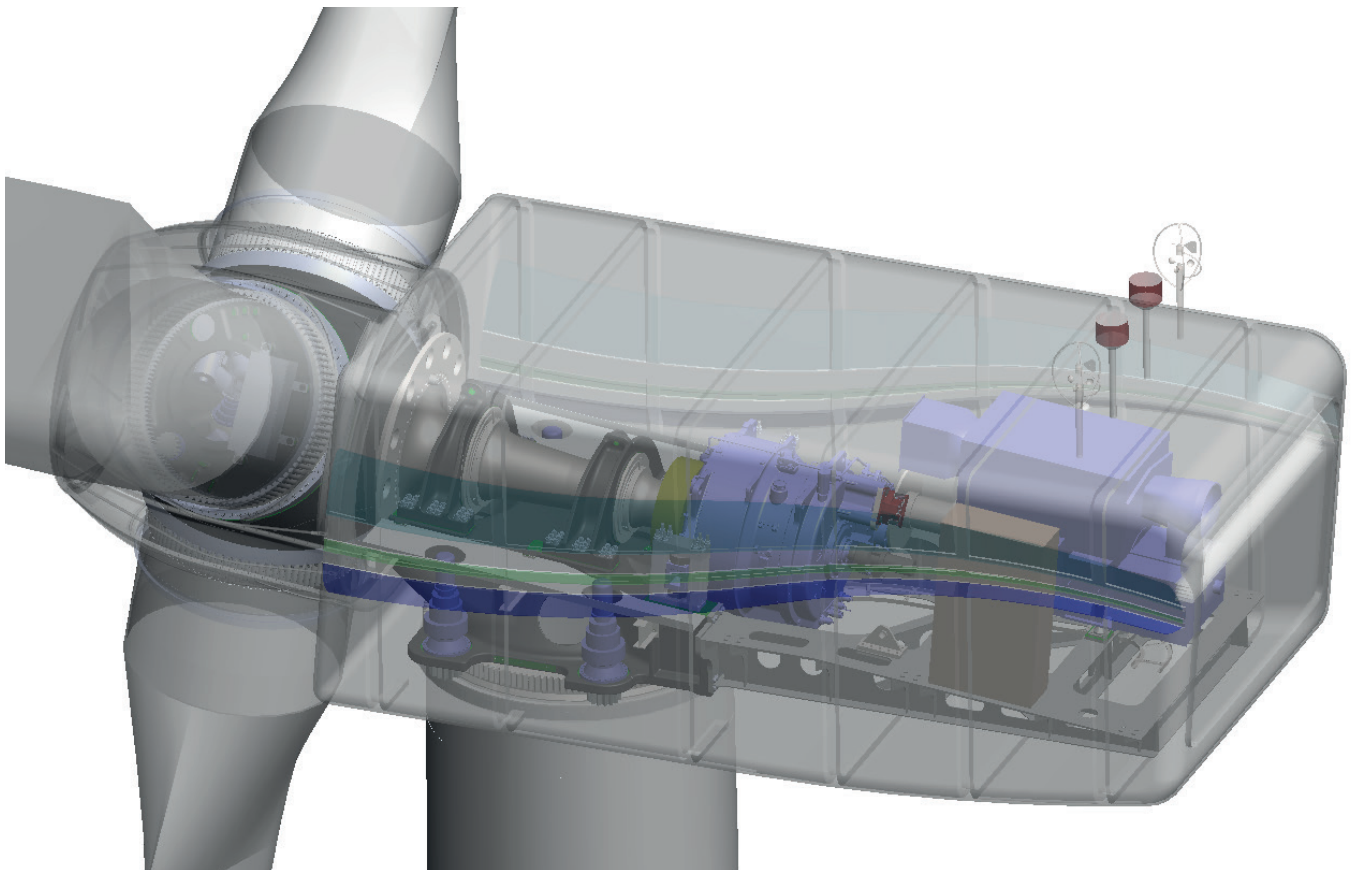

Broad expertise

Extensive experience and understanding from initial design through to commissioning.

The interactive nature of wind turbine design requires a very high level of communication between all involved in the project. DNV provides an integrated service with dedicated project teams that include all the necessary competencies: load calculations, electrical, mechanical and structural design, control algorithm design and controller implementation.

Turbine design specialists work alongside customers to establish their main design requirements, key parameter values (rotor diameter, hub height, rated power, etc), and overall turbine layout and drive train choice. This process is supported by advanced engineering cost models to minimize levelized cost of energy. If required, our experts can also assist with the selection of major components.

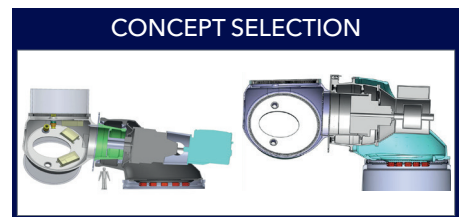

CONCEPT SELECTION

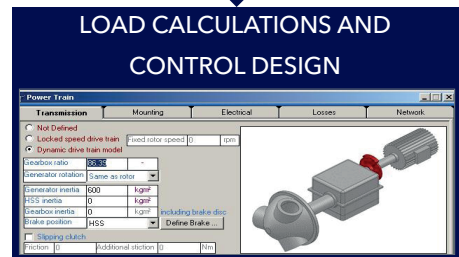

LOAD CALCULATIONS AND CONTROL DESIGN

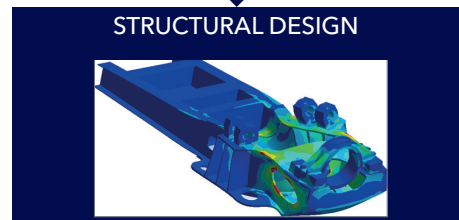

STRUCTURAL DESIGN



INTEGRATION AND TESTING

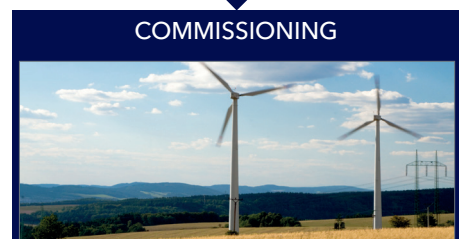

COMMISSIONING

Supporting turbine design at every stage

Whether you are a wind turbine manufacturer, a component supplier or an organization with a broader interest in wind turbine technology, we can provide expert advice to help you achieve your objectives.

Concept design

- Basic design parameters.
- Design standard.
- Wind class.
- Control and safety concept.
- Baseline loads.
- Layout.
- Power train arrangement.
- Sub-systems.
- Technical market study.
- Cost of energy analysis including offshore O&M.

Control systems

- Algorithm design.
- Prototype hardware implementation.
- Commissioning.
- Testing.

Electrical systems

- Generator specification.
- Converter specification.
- Auxiliary system requirements.
- Switchgear.
- Lightning protection.

Blade design

- Blade aero-stability analysis.
- Analysis and optimization of aerodynamic performance.

Performance and load calculations

- Numerical modelling.
- Load case definition.
- Mitigation of design driving loads.
- Design optimization.
- Certification ready loading reports.
- Site specific loads.

Mechanical engineering

- Blade specification.
- Hub design.
- Pitch system specification.
- Main bearing specification.
- Main bearing housing design.
- Main shaft design.
- Main and auxiliary frame design.
- Gearbox specification.
- Yaw system specification.
- Tower design.
- Rotor and yaw lock design.
- Finite Element Analysis.

Technology evaluation

- Fatal flaw analysis of disruptive innovations.
- Techno-economic quantification of innovations.

Wind turbine design track record

START /YEAR	MW	TURBINE TYPE	OTHER SPECIFICS	CLIENT/ COUNTRY	WORK SCOPE
2005	2	Geared, DFIG, onshore	Single main bearing housing 2 bearings, compact cast nacelle frame	Korea	Full prototype, finished
2006	1.5	Geared, DFIG, onshore	3 point drivetrain, cast nacelle frame, welded rear frame	China	Full prototype, finished
2008	2.0	Direct Drive, PMG, onshore	Compact design turbine, generator upwind from tower, cast nacelle structure	Holland	Part design, finished
2008	2.4	Direct Drive, PMG, onshore	Generator above tower, welded nacelle structure	Holland	Part design, finished
2008	2.4	Direct Drive, PMG, onshore	Generator in front of tower, cast nacelle structure	US	Part design, finished
2010	1.5	Geared, PMG, onshore	Hybrid gearbox-generator, cast mainframe	Japan	Part design, finished
2011	7	Geared, DFIG, offshore	Hybrid gearbox-generator, 3 point drivetrain, cast nacelle frame, welded rear frame	Korea	Full prototype, finished
2011	7	Geared, PMG, offshore	Mainshaft integrated gearbox, cast nacelle frame, welded rear frame	Korea	Full prototype, finished
2012	10	Geared, PMG, offshore	Kingpin design rotor, cast mainframe	China	Concept design, finished
2013	4	Geared, DFIG, onshore	4 point drive train, large rotor, welded rear frame	China	Full prototype, finished
2013	2	Geared, DFIG, onshore	4 point drive train, large rotor, welded rear frame	China	Full prototype, finished

Some of the turbine design projects that have been completed around the world.

Example turbine designs.

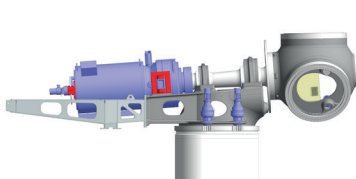

- 1.5MW, IEC IIIA

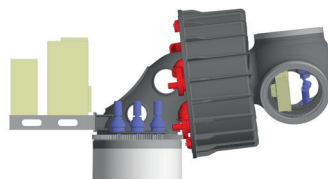

- 1.5MW, IEC IIA-III A

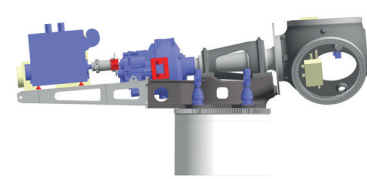

- 2.5MW, IEC IIA-III A

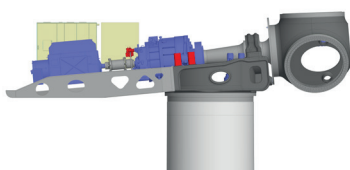

- 3MW, IEC IIA

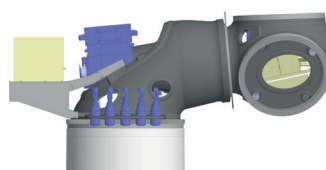

- 7MW, IEC IA

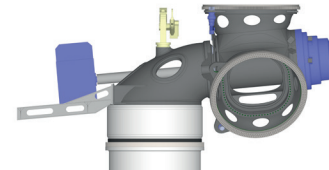

- 10MW - concept design

Bladed

The industry standard wind turbine design software.

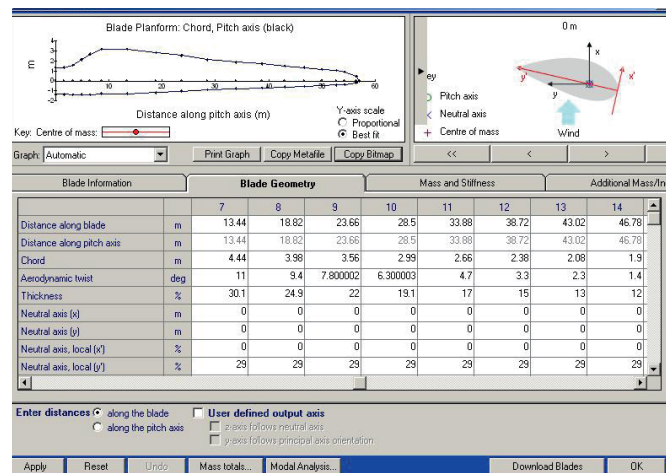
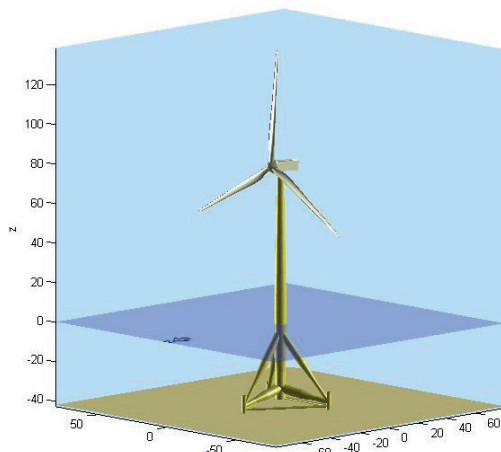

Bladed provides worldwide wind turbine and component manufacturers, certification agencies, design consultants and research organizations with a trusted design tool which has been extensively validated against measured data from a wide range of turbines. Bladed enables users to conduct the full range of performance and loading calculations. With a Windows-based user interface, it supports calculations of combined wind and wave loading, with full aeroelastic and hydroelastic modelling. Throughout the years Bladed has been validated by Germanischer Lloyd for the calculation of wind turbine loads for design and certification.

Bladed utilizes a completely self-consistent and rigorous multibody dynamics formulation of the structural dynamics. This provides consistently reliable and accurate results, forming a solid foundation from which to continue to extend the structural model with new features as part of the ongoing development programme for a wind turbine model.

Over the last two decades, as commercial wind turbines have grown in scale from 500kW to 7MW+, a dedicated team of wind energy experts have ensured that Bladed has developed to meet the increasingly complex technical challenges faced by wind turbine designers. Whilst customers old and new can be confident that Bladed is able to meet their immediate needs, they can also be reassured by our ongoing commitment to provide our customers with a high quality, state of the art software tool in the future.

Bladed currently features:

- Time-domain simulations of combined wind, wave and current loading on a wind turbine with full aeroelastic and hydroelastic modelling and seismic excitation, plus a range of supporting steady-state calculations.
- A range of additional modules for modelling offshore support structures and floating systems, control design and hardware-in the-loop testing, electrical modelling, and advanced drive train modelling.
- An extensive suite of post-processing functions, covering statistical and spectral analysis of simulation time-histories, through to the calculation and presentation of extreme and fatigue loads, and automatic reporting.
- A Windows-based graphical user interface and on-line help facility for ease of use.
- Validated against measured results from many different turbine configurations and ratings.
- Continuously updated and supported to react to new demands and requirements from the industry.

Knowledge transfer

DNV's training courses have been informing renewable energy professionals around the world for over 20 years.

Our engineers always work closely with our clients and so the sharing of knowledge is a natural process. However, many of our clients wish to extend this knowledge sharing or technology transfer to a larger number of staff than those intimately involved in the design process. In order to meet this requirement we offer a range of public and client specific technology training courses.

All of our training courses are tailored for professionals who wish to increase their knowledge of the key issues associated with wind turbine design.

We see training and technology transfer as key to the development of long term relationships with our clients. The process of sharing our expertise helps to deepen our understanding of the problems faced by our clients and identify gaps in knowledge that need to be addressed. By developing the capabilities within our clients' organizations our experienced engineers are freed up to tackle the more difficult issues faced by our clients ensuring that we provide them with the best possible value.

Bladed 5 day training course

The 5 day course is designed for new users of Bladed. It includes hands-on guided use of the software complemented by tutorials on key topics of wind turbine technology. By the end of the course participants will: understand the basic principles of a wind turbine; be able to build a complete wind turbine model and perform load calculations; have an understanding of control concepts; have an overview of site specific load calculations.

Topics covered within the course:

- Introduction to Bladed.
- Building a wind turbine model.
- Rotor aerodynamics.
- Structural dynamics.
- Control and safety systems.
- Modelling the environment.
- Running steady calculations.
- Running Simulations.
- Post-processing and reporting.
- The role of standards and certification.
- Offshore wind climate and wave loading.
- Offshore structures and foundations.
- Site specific load calculations.



Wind turbine technology 2 day training course

The 2 day wind turbine technology course is designed for newcomers to the wind industry. It covers the basics of wind energy conversion, the evolution of today's giant wind turbines and many key decisions about the design concepts (number of blades, upwind or downwind, etc.). Rotor design, direct drive and the increasing diversity of drive train options are examined. Permanent magnet generators and general electrical design issues are addressed.

The challenges of upscaling in the context of the offshore market are discussed. How design options may affect cost of energy and future trends are reviewed. The course offers a significant depth of understanding of the technology but does not assume any prior knowledge of wind energy.

Additional training courses

Alongside the well-established training courses on Bladed and Wind Turbine Technology, DNV offers training on the following topics:

- Controller design/controller implementation.
- Load calculations.
- Structural and mechanical design.
- Blade design.

Mechanical engineering

DNV operates at the leading edge of developments in the design of mechanical components, such as bearings, gears and bolted connections. Our specialists are able to analyse all major components, including rotor hubs, nacelle main frames, shafts and towers. Analysis is conducted using rigorous yet rapid methods that are well adapted to the design and development process, and are accepted by certifying bodies. Each design can be tailored to client needs and the target market.

The design of multi MW wind turbines continues to bring new challenges. The experience our engineers have acquired from involvement in many different projects, combined with state of the art tools and methods and an excellent understanding of the capabilities of the supply chain, puts DNV in a unique position to provide design services to existing players and new entrants to the industry.

Case study: Optimum drive train topologies for large offshore wind turbines presented at Hamburg Offshore Wind 2013

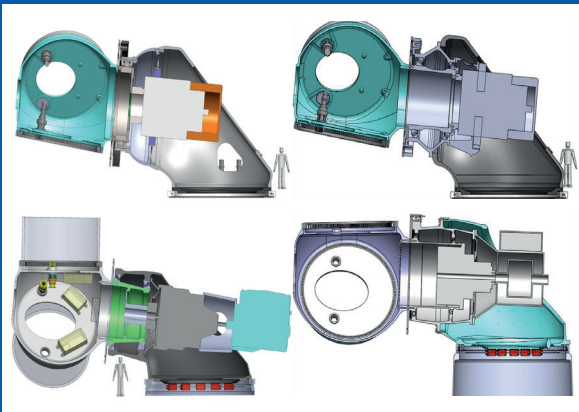

When developing a large offshore wind turbine many, often interacting, factors need to be taken into account to determine the levelized cost of the energy (LCoE). Both CAPEX, associated with the turbine and the balance of plant, and OPEX, which is determined by reliability and O&M strategy, must be considered. DNV has developed a robust cost model that allows rapid evaluation of different concepts to determine which offers the best LCoE.

The development of new concepts also requires a thorough understanding of supply chain capabilities and any constraints that may be imposed, e.g. the maximum casting size for hubs, or bearing size limits imposed by the hardening process. Regular contact with companies in the supply chain allows our engineers to understand the constraints and apply pressure to advance the capability, to benefit our customers.

Control system

DNV is the industry leader for wind turbine control systems design and development of multivariable control algorithms which alleviate turbine structural loads and optimize energy capture.

Our Implementation and Test services include the development and provision of fully functional turbine controllers which run on industrial Programmable Logic Controller (PLC) platforms. From the early design stages to prototype commissioning, integration testing underpins controller development. This hardware-in-the-loop testing capability is provided by the Bladed Hardware Test module. Our engineers always work in close collaboration with customers, providing significant technology transfer and tailored training.

- World leading algorithm design - DNV is acknowledged as the foremost wind turbine control algorithm design organization.
- No series production fees - Our customers are free to replicate the controller software for turbine model series production for which the control system was designed. No further permission or payment is required by DNV.
- No hardware tie-in - DNV is an independent industry adviser. We are able to implement the controller on a wide range of popular PLC platforms and with interfaces to almost all of the established wind energy sub-system suppliers.

- Open working arrangement - DNV will provide full explanation of, and any training necessary to allow our customers to understand and modify, all parts of the control system software function.
- Proven wind turbine controller testing - Controller testing tools are based on our industry standard Bladed software. The customer may purchase the testing tools as an addition to Bladed for subsequent in-house testing.
- On-site support - Our engineers co-ordinate, verify and delve into the detail to root out operational problems at factory tests and in operational turbines.

DNV provides a streamlined control system development service, from algorithm design through to commissioning support. Our engineers are familiar with a wide range of PLC platforms and by integrating robust testing methods within each development cycle we ensure that all aspects of the controller are validated and interoperability with key subsystems verified during testing sessions in the factory, well before final handover at turbine commissioning.

Case study: Controller implementation for a new 3mw turbine

Customer: China Northern Railways (CNR)

In developing its third generation wind turbine, rated at 3MW, CNR turned to DNV to provide both the design load analysis and turbine control system.

DNV designed, implemented, tested and commissioned the full turbine controller software, including the interfaces to all subsystems – pitch system, power converter, yaw system, vibration and grid monitoring, SCADA, safety chain and auxiliaries.

The controller package delivered to CNR also included a Human Machine Interface for use by operations and maintenance technicians.

CNR and DNV engineers cooperated closely throughout the project to ensure the best possible outcomes. The turbine controller was successfully commissioned at the Zhangbei City site (Hebei Province) in October 2012.

Research and development

A wealth of experience applied to world leading research and development.

DNV continually strives to maintain its position at the forefront of the renewable energy industry. In order to maintain this position and keep abreast of new developments, we are heavily involved in and lead many research and development projects to ensure that renewable energy technologies become more robust and cost effective.

Wind power is now fully established as a significant contributor to the energy mix in both the developed and developing world. In order for this contribution to continue to increase, wind turbines must be made more cost effective whilst also meeting the challenges of increasingly hostile operational environments. At DNV, we are therefore committed to research and development as it underpins all of our efforts as we continually aim to improve our existing services and strive to develop new business streams.

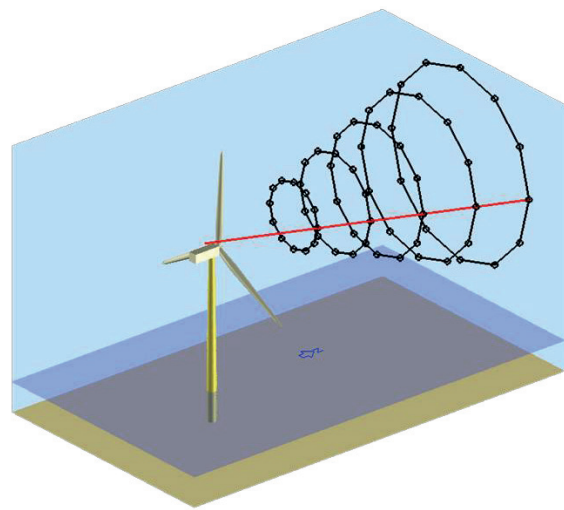

Using Bladed to model a Lidar device for power production control.

Case study: Offshore code comparison

Customer: IEA

The validation of numerical models for the calculation of floating wind turbine behaviour will only be possible when full scale machines are operating and appropriate measured data is collected.

In the short to medium term, an alternative approach is required to verify that the codes being developed will reproduce the behaviour of and loading experienced by floating wind turbines.

The Offshore Code Comparison set up under the IEA aims to ensure that codes being developed are robust through a rigorous and widely publicized comparison exercise using a representative 5MW wind turbine

model mounted on a range of support structures. The approach starts from the basics, separately verifying structural dynamics, hydrostatics, aerodynamics and hydrodynamics before combining them and comparing the resulting differences in fatigue loads and extremes in a limited set of circumstances.

The latest phase of the project uses a semi-submersible support structure. DNV has determined how to best use a traditional Morison's equation approach to model the hydrodynamics as well as using the project to verify its latest developments in hydrodynamic and mooring line modelling.

Case study: Wind turbine control applications of turbine-mounted lidar

Presented at 'The Science of Making Torque from Wind 2012'

DNV has been at the forefront of wind turbine control system development for more than two decades. This study was undertaken owing to the significant interest in the use of LIDAR in wind turbine control and the dramatic claims of increased energy capture and reductions in loading. DNV undertook an independent and objective study that was co-funded by two leading LIDAR suppliers.

The key objectives were to:

- Evaluate the likely benefits of adding LIDAR to the wind turbine controller.
- Provide advice to LIDAR manufacturers about LIDAR system characteristics which are most likely to be of value for this application.



By enhancing Bladed to include the modelling of LIDAR, it was possible to demonstrate very significant load reductions even with simple control algorithms. The benefits of optimum power coefficient tracking were shown to be less clear. In order to get maximum benefit, the LIDAR system must be able to give good quality data for a few seconds of look-ahead time.



Case study: Dynamic stall model for investigating stall flutter

Presented at 'The Science of Making Torque from Wind 2012'

As wind turbine blades become larger there is a tendency for the blade torsional stiffness to reduce, with the increased risk of aeroelastic instability at moderate wind speeds.

Whilst linearized methods can assess the envelope of allowable blade properties to avoid classical flutter in attached flow, wind turbine aerofoils often experience stalled flow.

Through the implementation of a dynamic stall model which incorporates all the important flow features associated with both leading and trailing edge stall it has been possible to investigate the impact of stalled flow on the predicted flutter speed for a multi-megawatt wind turbine blade.

Performance and load calculations

Using Bladed, the industry standard software package developed in house over many years, DNV provides a robust and reliable performance and load calculations service based on in-depth knowledge of all relevant design standards and certification rules.

Through our ongoing involvement in the development of international standards, DNV's engineers maintain an up to date understanding of the design load calculation requirements for both onshore and offshore wind turbines. We also ensure that Bladed is equipped with all the features necessary to provide our customers with a rapid and robust load calculation service.

Design loads are computed for all structural components in the turbine nacelle (hub, mainframe, etc), specifications of subsystems (gearbox, bearings, etc) and for the design of support structures for onshore and offshore wind turbines.

Case study: Design methods for offshore wind turbines at exposed sites (OWTES)

Customer: European Commission

DNV has led the European Commission funded OWTES project which was formulated to reduce the uncertainties associated with the design and installation of offshore wind turbines at hostile exposed sites. At the core of the OWTES project was a sixteen-month data collection period from one of the two Vestas V66 wind turbines installed in the Blyth offshore wind farm. These turbines were the first to be installed in the North Sea and the first to experience significant wind and wave loading. A comprehensive monitoring system was installed on one of these turbines, capable of recording the environmental conditions at the turbine (wind, waves and currents) and the resulting structural loads.

The database of measurements collected was used by OWTES project partners to assess many aspects of the design process for offshore wind turbines. The measurements database was used to verify and enhance state-of-the-art design tools for offshore wind turbines. The measured turbine performance and loads were compared to predictions made by Bladed.

Comparing the measured and predicted loads made it possible to determine values of wave loading coefficients for use in future design work. The project confirmed that a correct dynamic model of the turbine structure is critical for the accurate prediction of fatigue and extreme loads. Natural frequencies of turbine structure vibration were predicted accurately by Bladed. In addition, the importance of aerodynamic damping of wave-induced tower vibration in reducing fatigue loads was confirmed by the measurements. This had previously only been predicted in theory.

An important objective of the OWTES project was to review existing design standards for offshore wind turbines and to make improvement recommendations, where appropriate. It was concluded that the generic certification of an entire offshore wind turbine system is not possible due to the very site-specific nature of the support structure design. However, the load influence of waves on tower top machinery is very small and generic rather than site-specific machinery designs may be developed.

Assessing new technologies

Modern wind turbines are complex machines that combine components based on a range of engineering disciplines including aerodynamics, structural, electrical, mechanical and civil engineering. When assessing technological innovation impact it is essential that a rigorous approach is used to ensure that benefits and risks are weighed against potential costs. DNV has developed a series of engineering models for the turbine and support structure, balance of plant and operations and maintenance that can be used to assess the through-life impact of design changes on the levelized cost of energy.

This cost of energy modelling plays a central role in turbine concept design and in the evaluation of new technologies and concepts such as:

- Aerodynamic design.
- Advanced blade materials.
- Control strategies.
- Sub systems e.g. pitch and yaw drives.
- Drive train configurations.
- Operations and maintenance strategies.

Distilling the knowledge and experience available within DNV's Turbine Engineering team we have developed cost models that can be used to assess technological innovations with a high degree of confidence. Assessing the through life impact of design changes can equip our clients with the knowledge they require to make informed investment decisions.

Case study: Finding a levelized cost of energy sweet spot for the rotor size and rating of an offshore wind turbine

DNV worked for a large industrial conglomerate to identify the sweet spot of turbine rating and rotor size, where the Levelized Cost of Energy (LCoE) would be minimal in the Northern European offshore target market. Our in-house developed engineering models for the turbine, offshore balance of plant and offshore operation & maintenance activities allowed a fast sweep of a wide variable space. The LCoE trends with turbine size identified a LCoE sweet spot.

Estimates of component failure rates were used as input to the O&M modelling to assess uncertainty in predicted LCoE. The LCoE study enabled the client to make a well informed and swift decision on the turbine size.

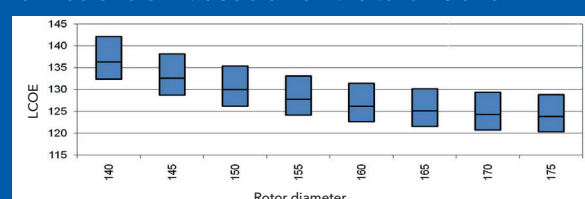



ABOUT DNV

DNV is an independent assurance and risk management provider, operating in more than 100 countries. Through its broad experience and deep expertise DNV advances safety and sustainable performance, sets industry standards, and inspires and invents solutions.

We provide assurance to the entire energy value chain through our advisory, monitoring, verification, and certification services. As the world's leading resource of independent energy experts and technical advisors, we help industries and governments to navigate the many complex, interrelated transitions taking place globally and regionally, in the energy industry. We are committed to realizing the goals of the Paris Agreement, and support our customers to transition faster to a deeply decarbonized energy system.

Regional Energy Systems Offices

Americas

155 Grand Avenue Suite 600
Oakland CA 94612
USA
Phone +1 510 891 0446
Email contact.energysystems@dnv.com

Asia Pacific

No.5 Jinghua South Street Office Park,
Tower C, 9th Floor Chaoyang District
100020 Beijing
Greater China
Phone +86 106 562 7888
Email contact.energysystems@dnv.com

Europe

Utrechtseweg 310 Building B50 (Energy
Business Park - Arnhems Buiten)
6812 AR Arnhem
Netherlands
Phone +31 263 569 111
Email contact.energysystems@dnv.com

Middle East

Sheikh Zayed Street, BurJuman Business Tower
12th and 14th Floor Bur Dubai
11539 Dubai
United Arab Emirates
Phone +971 430 26 300
Email contact.energysystems@dnv.com

UK & Ireland

One Linear Park, Avon Street
Temple Quay, Bristol BS2 0PS
United Kingdom
Phone +44 117 972 9900
Email contact.energysystems@dnv.com

Disclaimer

All information is correct to the best of our knowledge. Contributions by external authors do not necessarily reflect the views of the editors and DNV AS.

DNV

Brooktorkai 18
20457 Hamburg, Germany
Phone +40 361400
www.dnv.com

DNV AS

NO-1322 Hovik,
Norway
Tel +47 67 57 00
www.dnv.com